

Каталог мебели



Содержание каталога

Столы письменные	3
Столы письменные (двухтумбовые)	3
Столы эргономичные	3
Столы аудиторские (приставные)	4
Столы компьютерные	4
Столы компьютерные угловые	4
Столы журнальные	5
Секции угловые	5
Шкафы для документов	6
Шкафы-пеналы для документов	7
Стойки архивные	7
Шкафы одежные	8
Шкафы картотечные	9
Шкафы картотечные (с ящиками)	9
Шкафы-купе	10
Антресоли	11
Тумбы функциональные под аппаратуру	11
Тумбы выкатные	11
Тумбы прикроватные	12
Полки навесные; L = 80 см	12
Полки навесные; L = 120 см	13
Кровати (взрослые)	13
Кровати (детские)	14
Столы лабораторные	14
Шкафы лабораторные	15
Столы пеленальные	16
Тумбы лабораторные	16
Мойки лабораторные	16
Сопутствующие товары	16

I Столы письменные

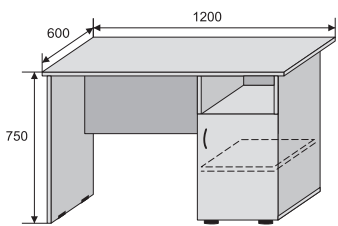

СП-01

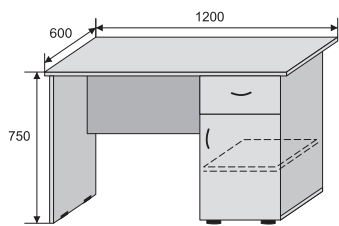

СП-02

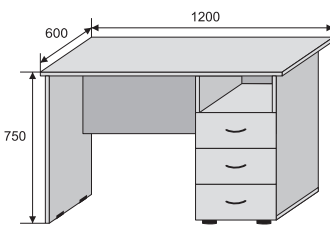

СП-03

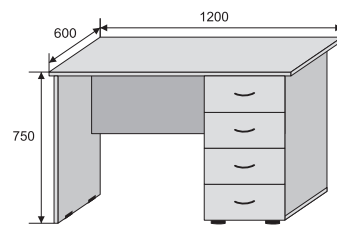

СП-04

II Столы письменные (двухтумбовые)

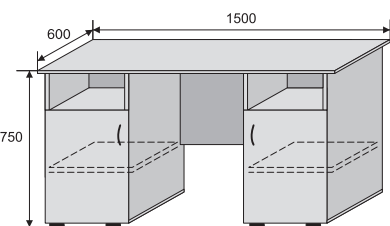

СП-05

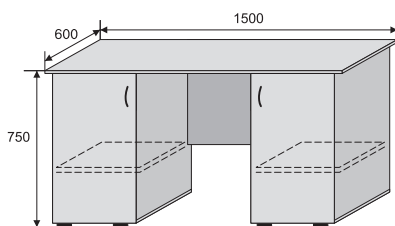

СП-06

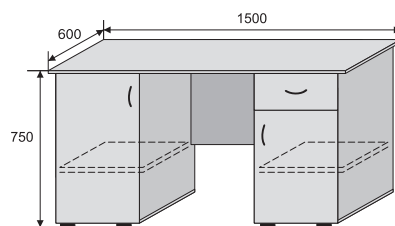

СП-07

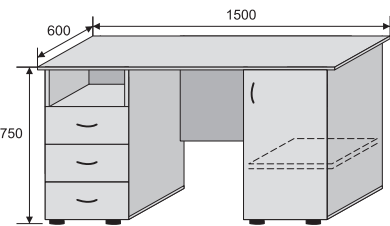

СП-08

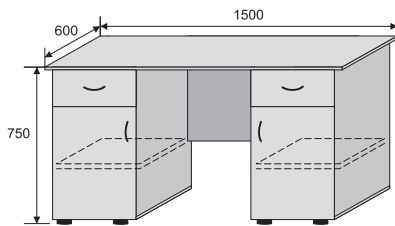

СП-09

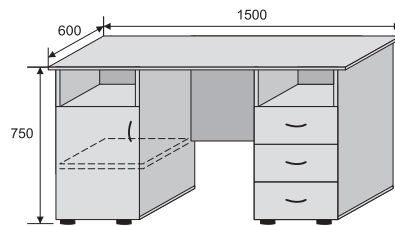

СП-10

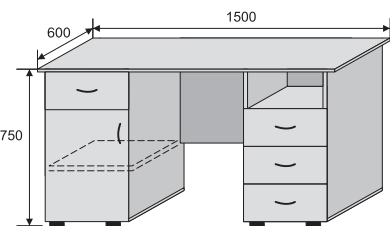

СП-11

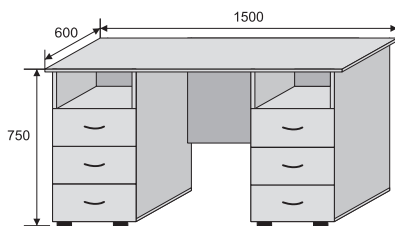

СП-12

III Столы эргономичные

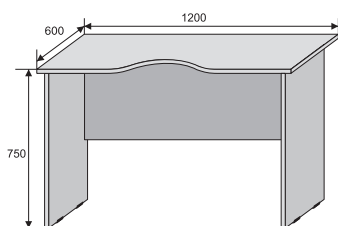

СЭ-01

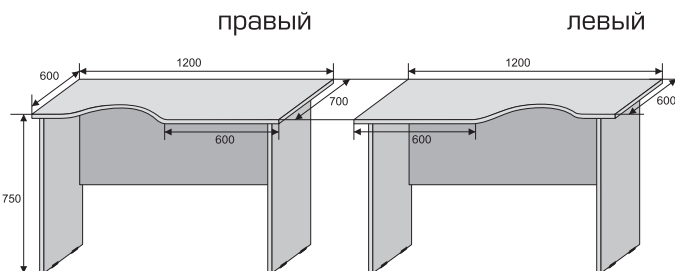

СЭ-02

СЭ-03

IV Столы аудиторские (приставные)

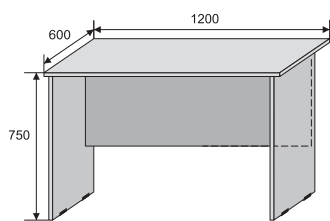

CA-01

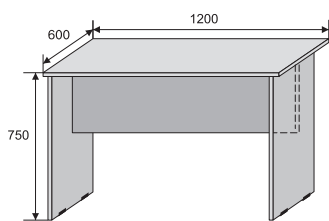

CA-02

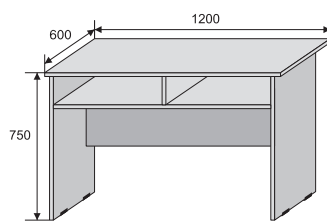

CA-03

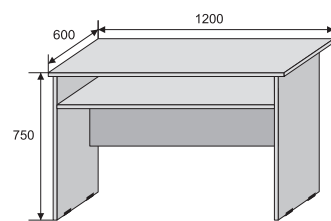

CA-04

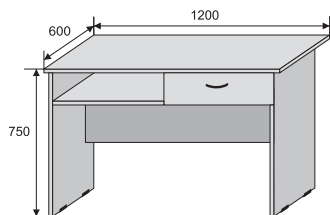

CA-05

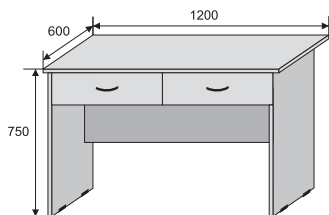

CA-06

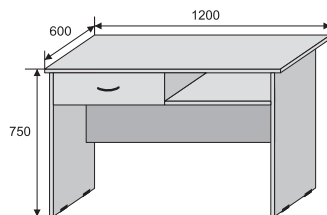

CA-07

V Столы компьютерные

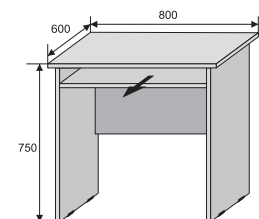

CK-01

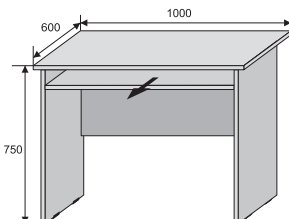

CK-02

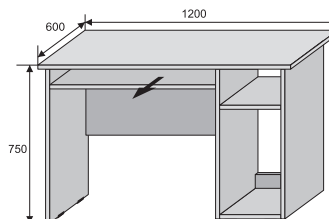

CK-03

VI Столы компьютерные угловые

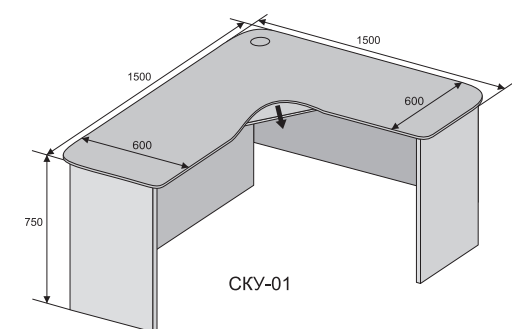

SKY-01

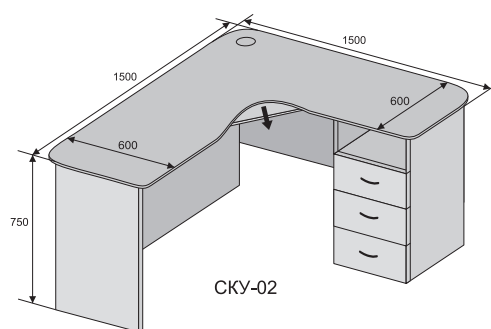

SKY-02

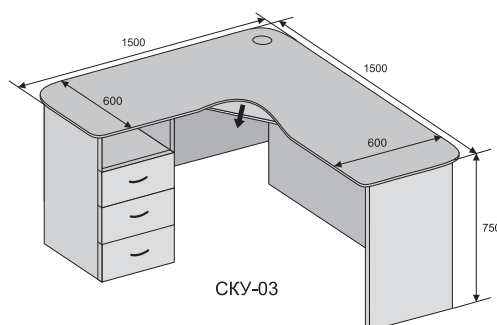

SKY-03

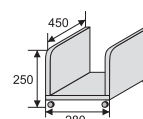
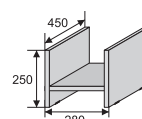
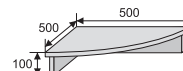
Тележка под
сист. блок СБ-01Подставка под
сист. блок СБ-02Подставка под
монитор ПМ-01

VII Столы журнальные

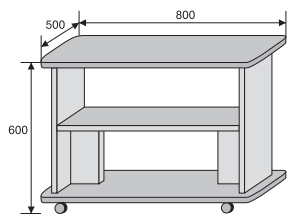

СЖ-01

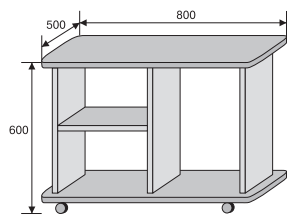

СЖ-02

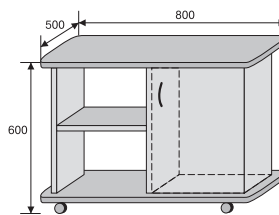

СЖ-03

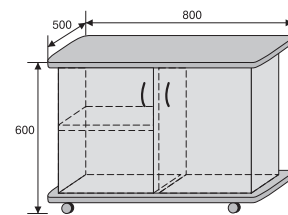

СЖ-04

VIII Секции угловые

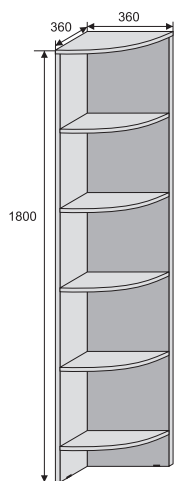

СУ-01

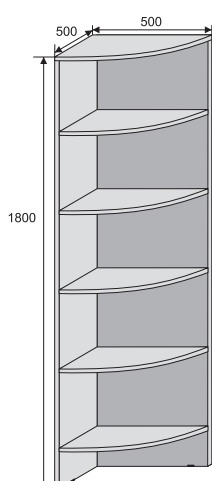

СУ-02

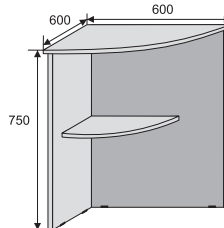

СУ-03

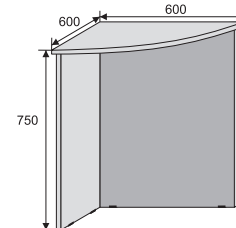

СУ-04

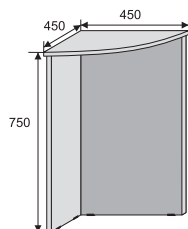

СУ-05

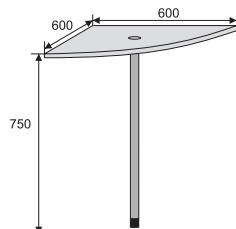

СУ-06

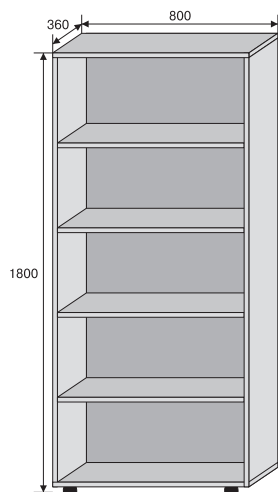
 Шкафы для документов

ШД-01

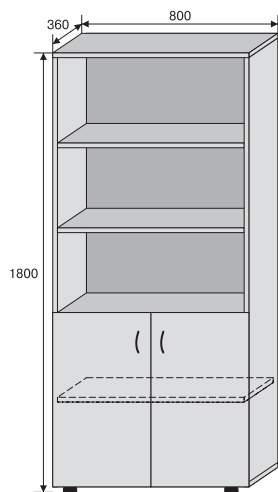

ШД-02

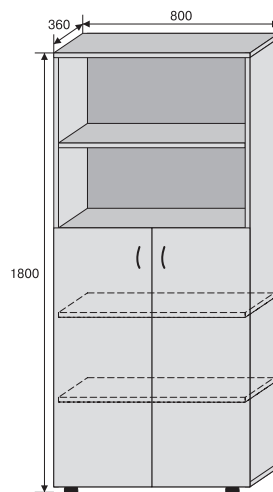

ШД-03

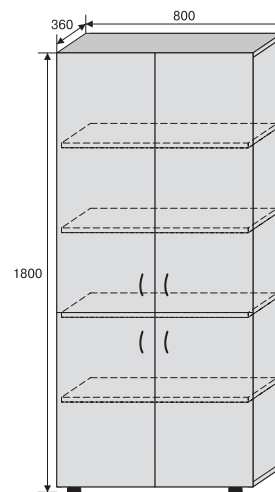

ШД-04

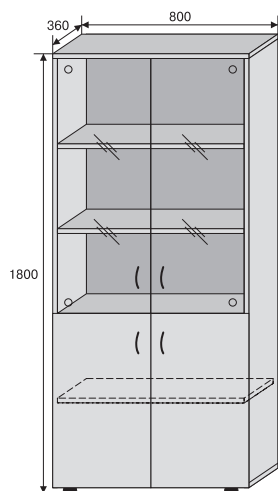

ШД-05

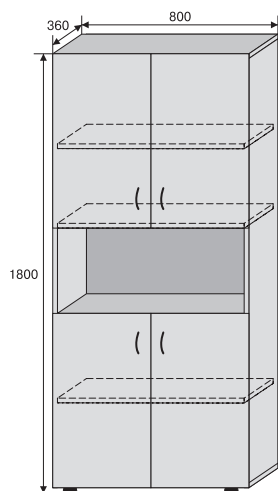

ШД-06

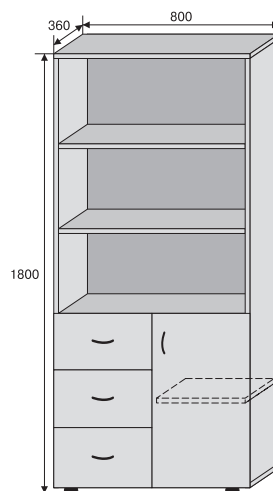

ШД-07

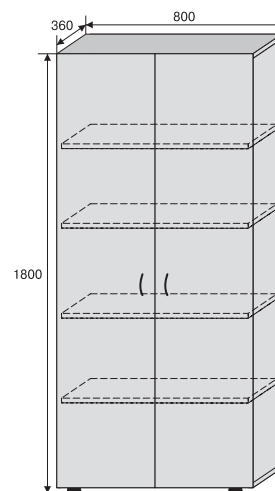

ШД-08

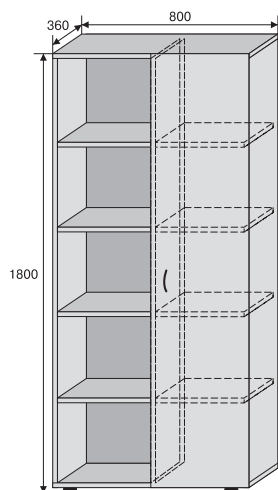

ШД-09

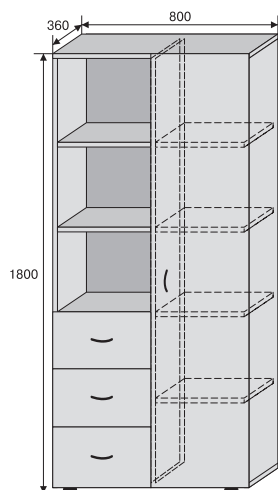

ШД-10

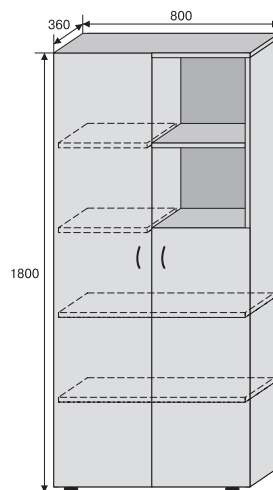

ШД-11

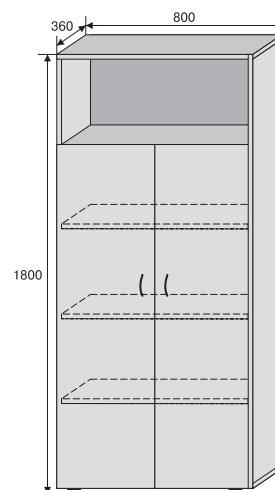

ШД-12

Шкафы-пеналы для документов

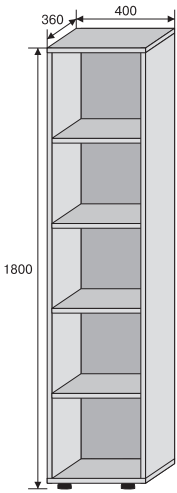

ШП-01

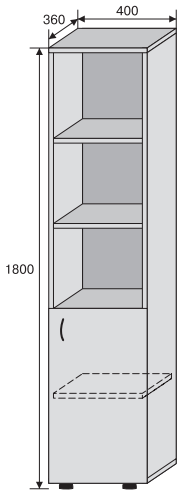

ШП-02

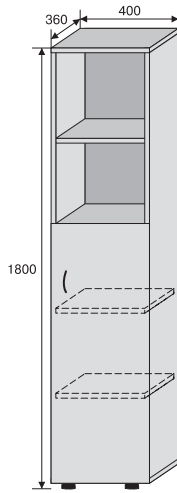

ШП-03

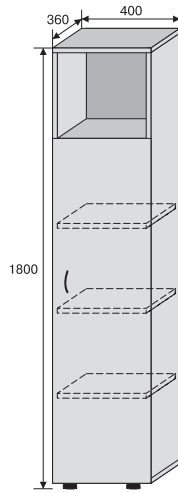

ШП-04

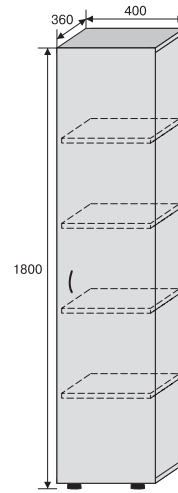

ШП-05

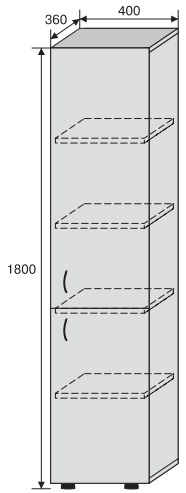

ШП-06

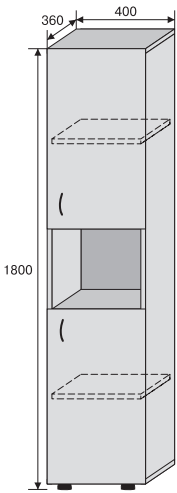

ШП-07

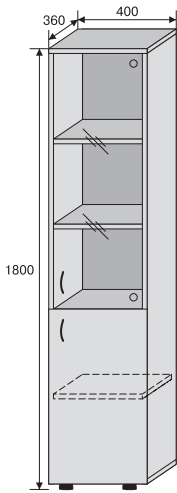

ШП-08

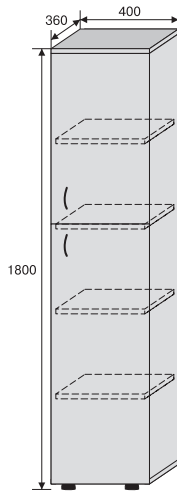

ШП-09

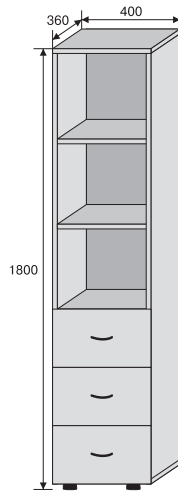

ШП-10

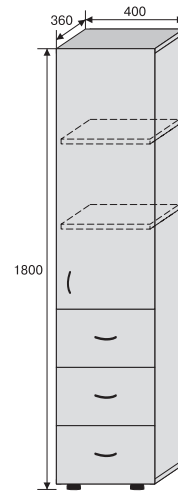

ШП-11

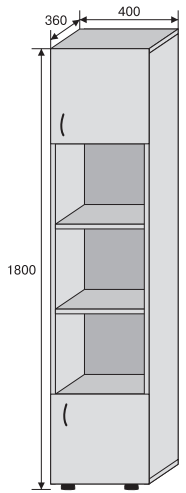

ШП-12

Стойки архивные

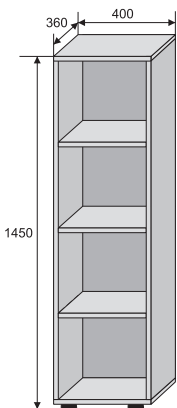

СТО-01

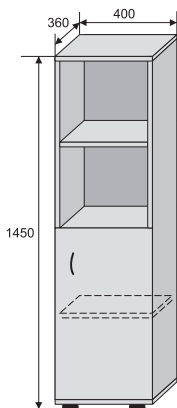

СТО-02

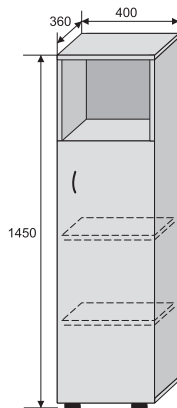

СТО-03

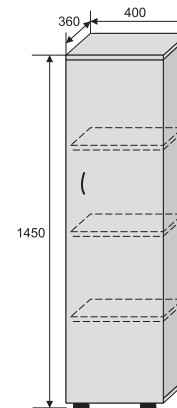

СТО-04

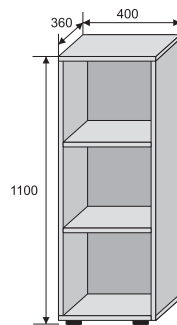

СТО-05

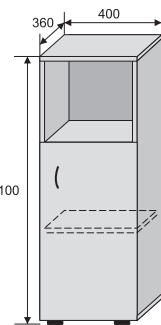

СТО-06

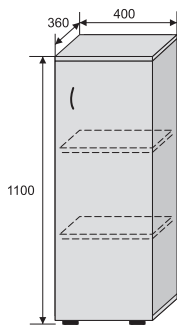

СТО-07

XII Шкафы одежные

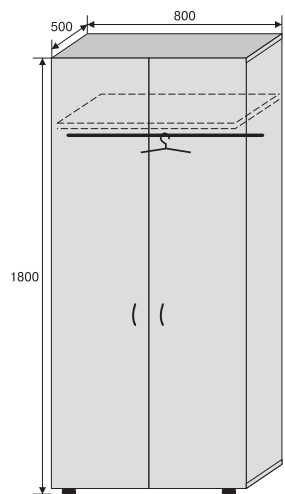

ШО-01

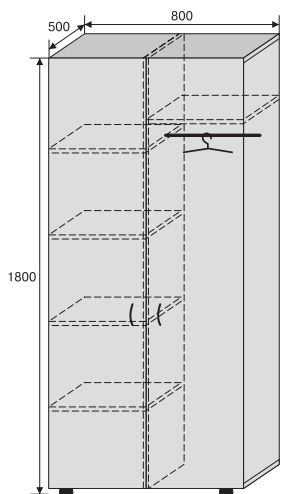

ШО-02

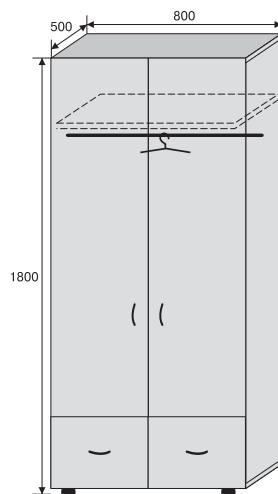

ШО-03

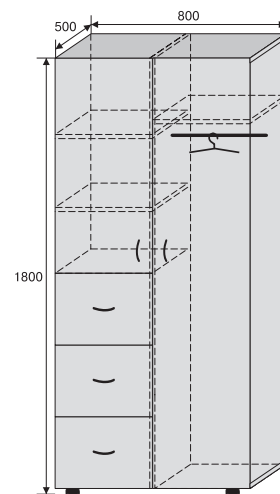

ШО-04

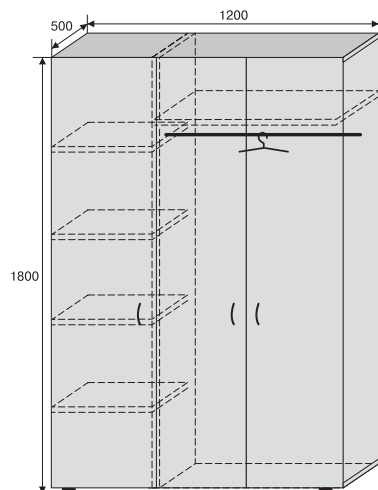

ШО-05

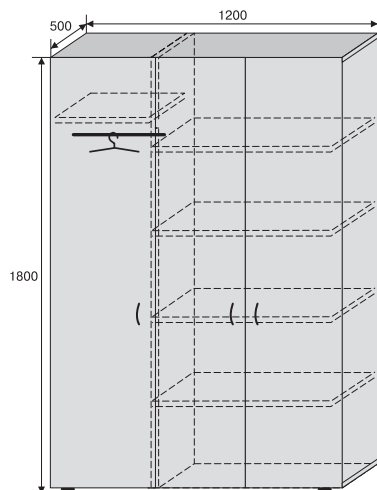

ШО-06

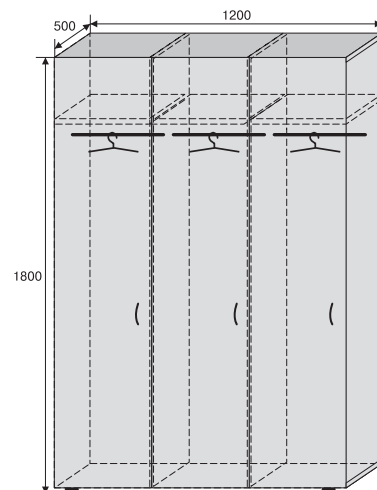

ШО-07

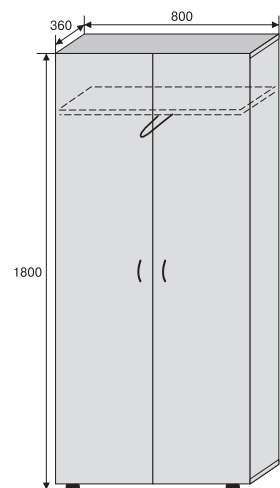

ШО-08

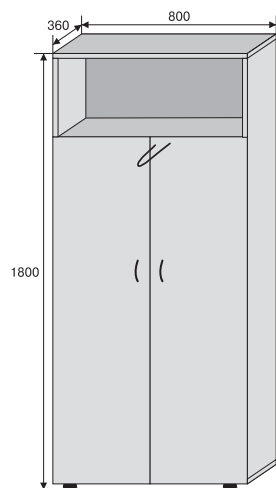

ШО-09

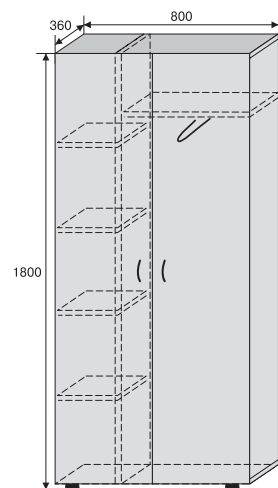

ШО-10

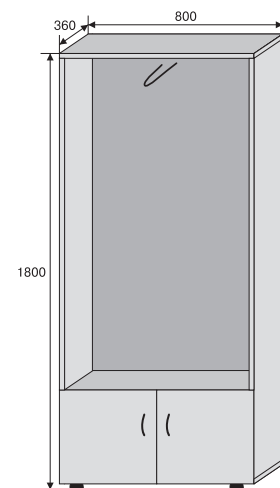

ШО-11

XIII Шкафы картотечные

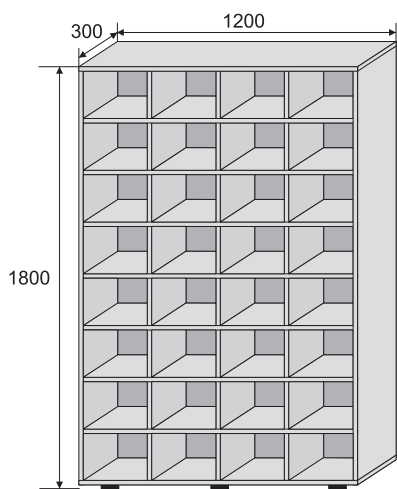

ШК-01

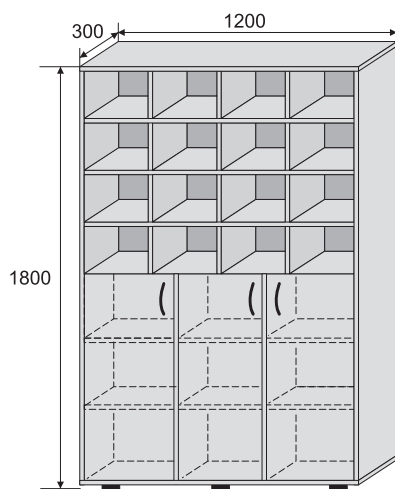

ШК-02

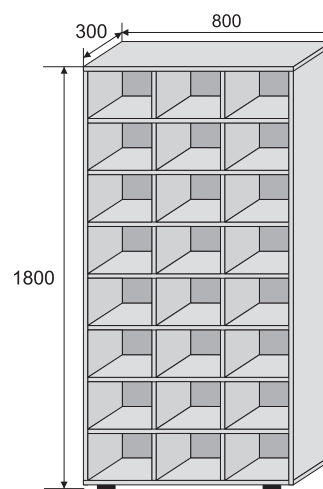

ШК-03

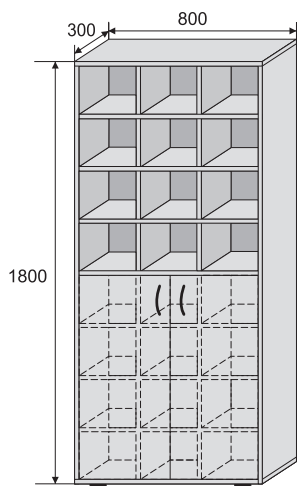

ШК-04

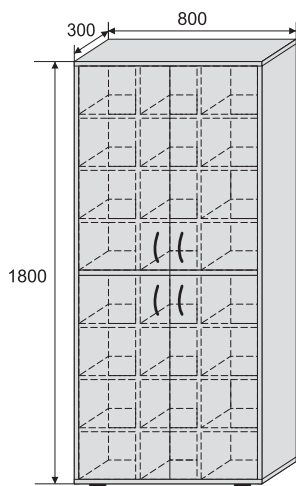

ШК-05

XIV Шкафы картотечные (с ящиками)

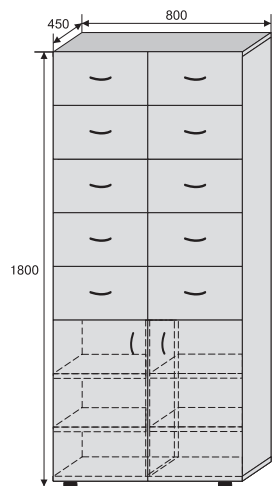

ШК-06

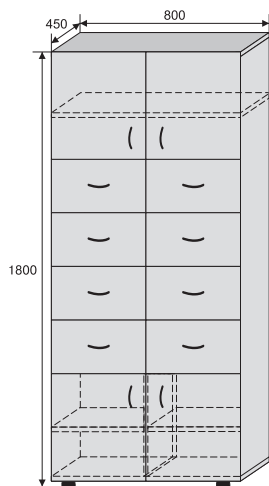

ШК-07

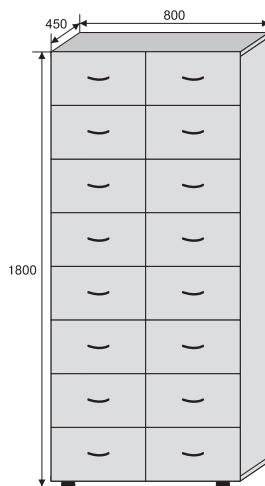

ШК-08

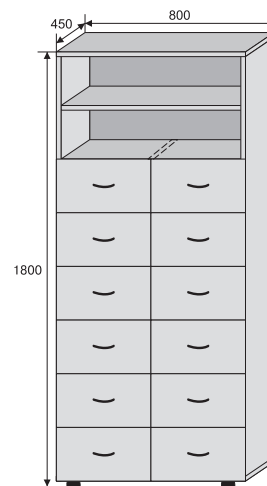

ШК-09

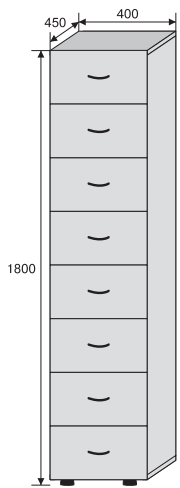

ШК-10

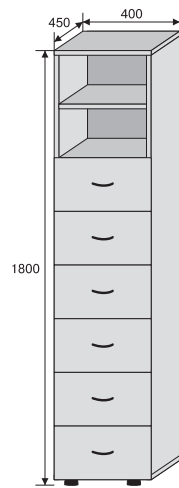

ШК-11

xv Шкафы-купе

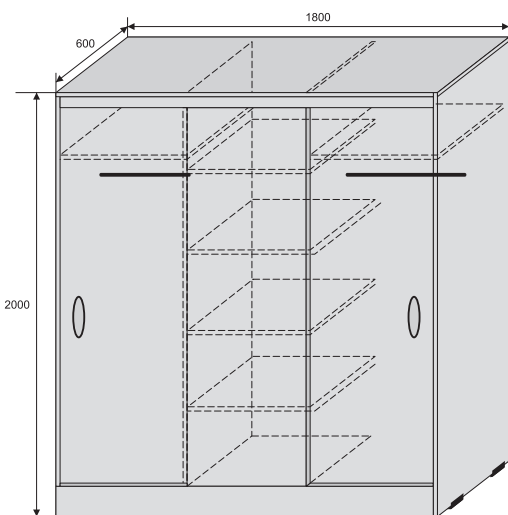

K-01

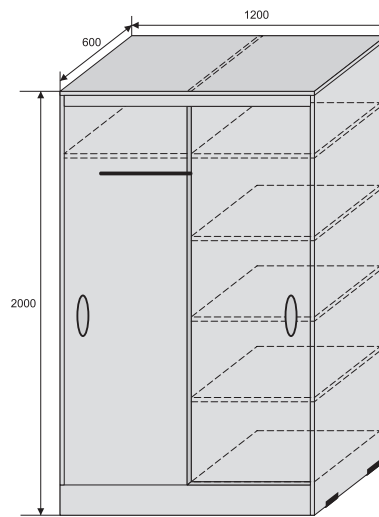

K-02

В шкафах-купе
используются
направляющие
фирмы "Hettich"
(система верхнего
подвеса дверей).

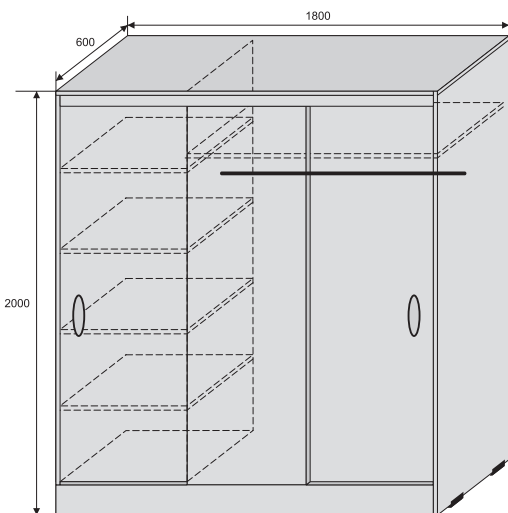

K-03

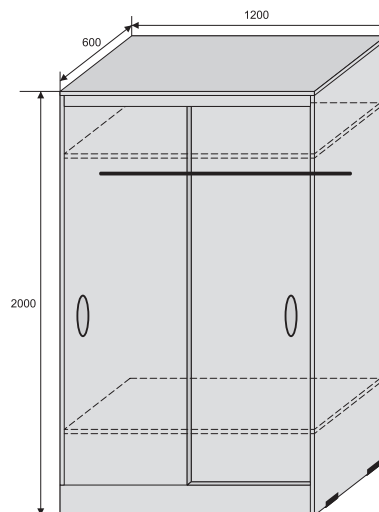

K-04

xvi Антресоли

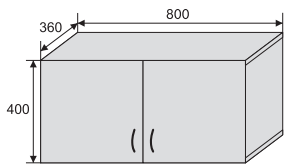

A-01

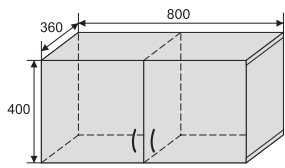

A-02

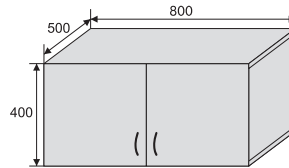

A-03

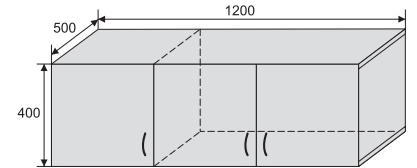

A-04

xvii Тумбы функциональные под аппаратуру

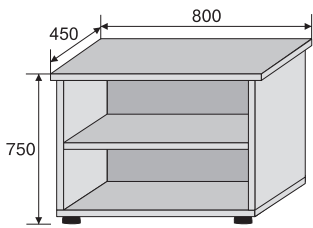

TФ-01

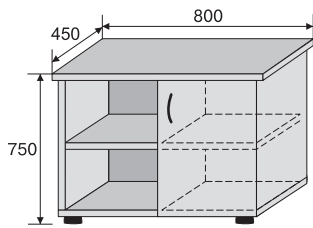

TФ-02

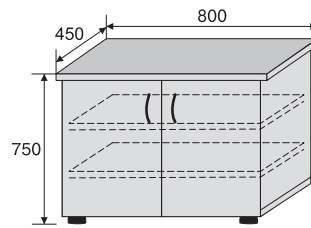

TФ-03

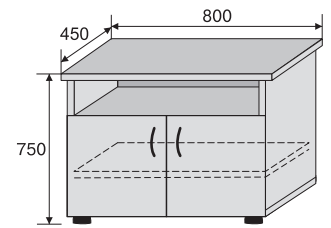

TФ-04

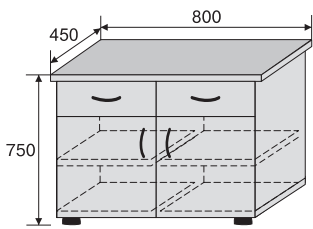

TФ-05

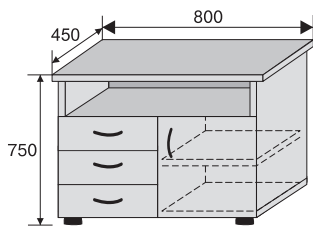

TФ-06

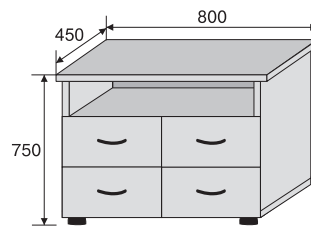

TФ-07

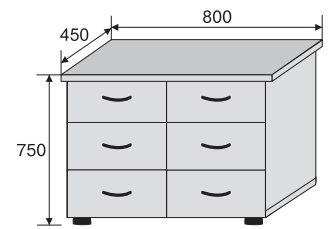

TФ-08

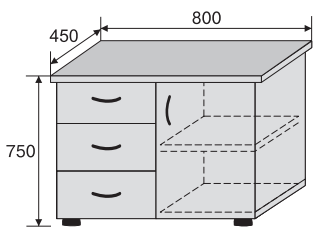

TФ-09

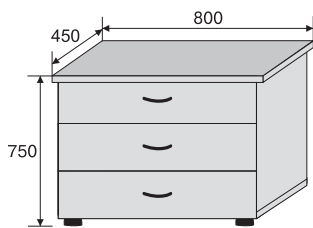

TФ-10

xviii Тумбы выкатные

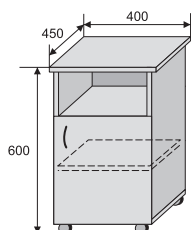

TB-01

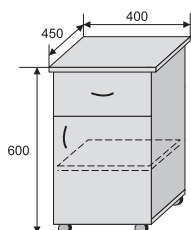

TB-02

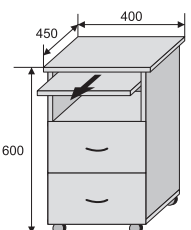

TB-03

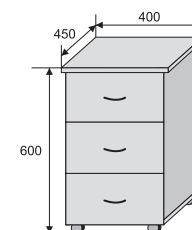

TB-04

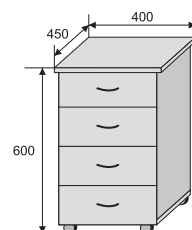

TB-05

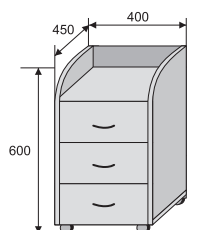

TB-06



Тумбы прикроватные

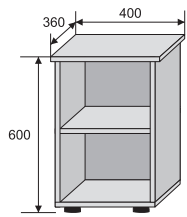

ТП-01

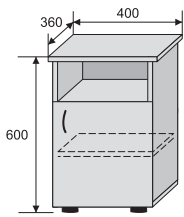

ТП-02

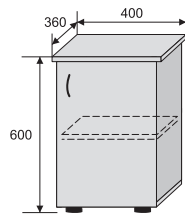

ТП-03

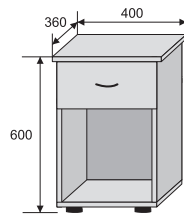

ТП-04

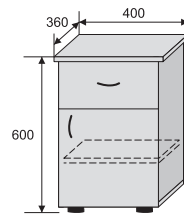

ТП-05

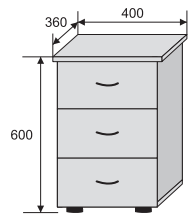

ТП-06

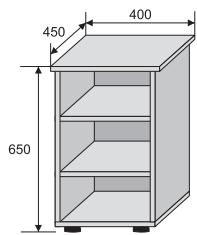

ТП-07

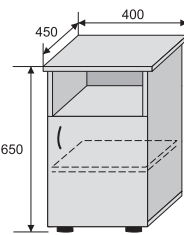

ТП-08

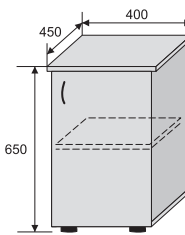

ТП-09

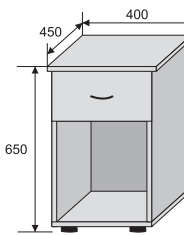

ТП-10

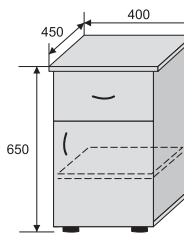

ТП-11

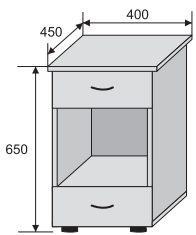

ТП-12

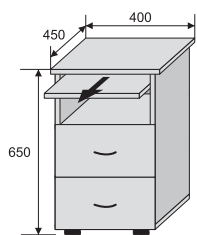

ТП-13

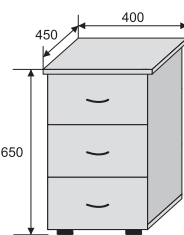

ТП-14

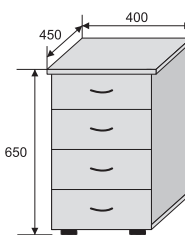

ТП-15



Полки навесные; L = 80 см

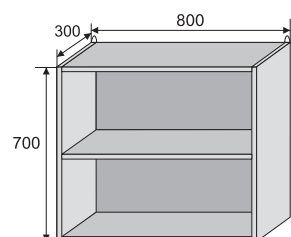

ПН-01

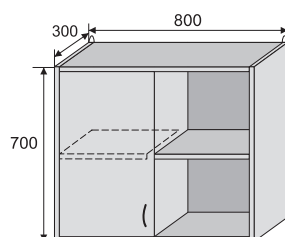

ПН-02

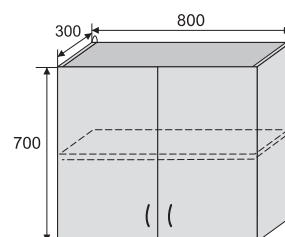

ПН-03

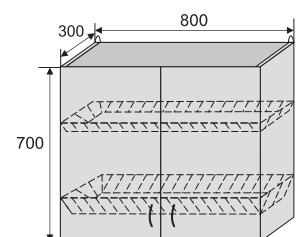

ПН-04

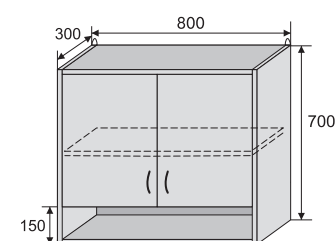

ПН-05

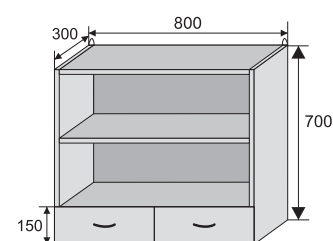

ПН-06

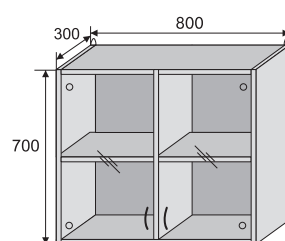

ПН-07

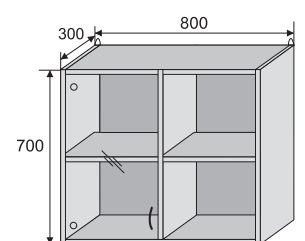

ПН-08

XXI Полки навесные; L = 120 см

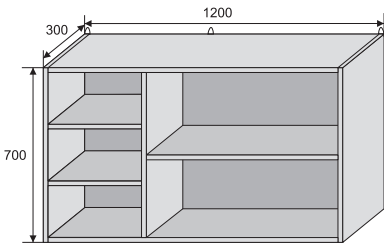

ПН-09

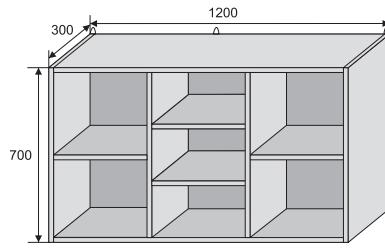

ПН-10

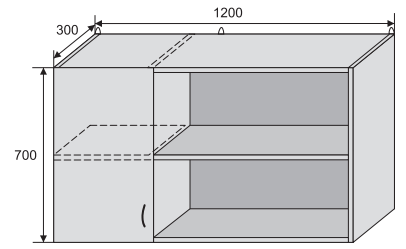

ПН-11

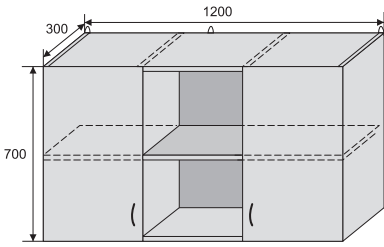

ПН-12

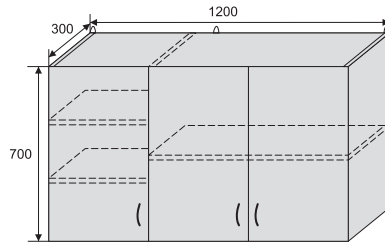

ПН-13

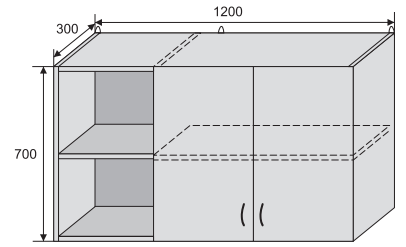

ПН-14

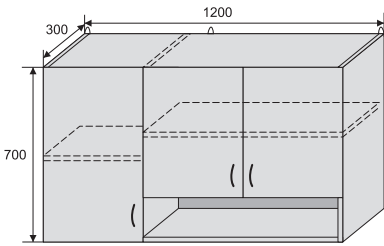

ПН-15

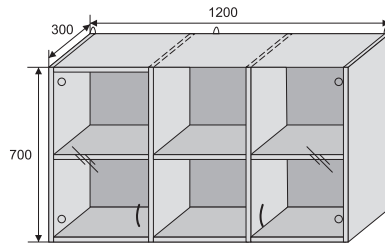

ПН-16

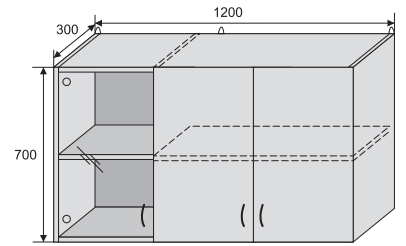

ПН-17

XXI Кровати (взрослые)

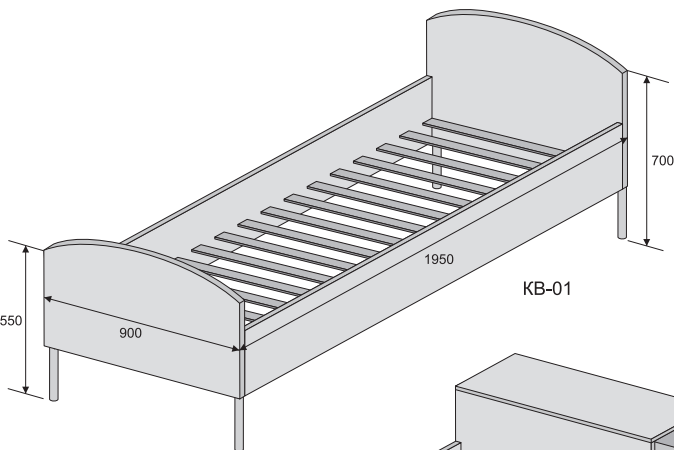

KB-01

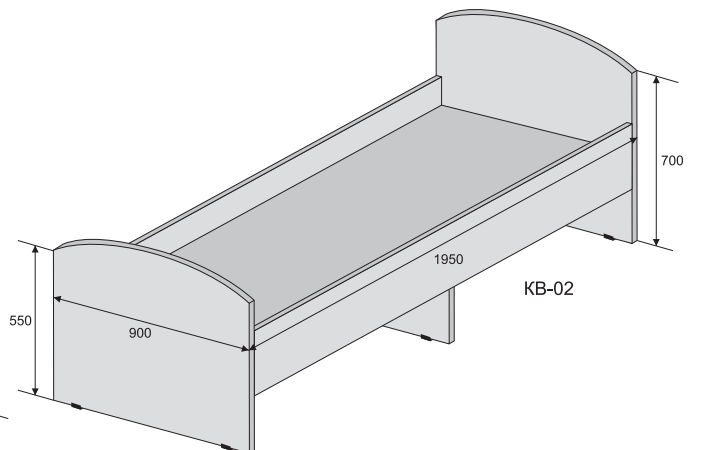

KB-02

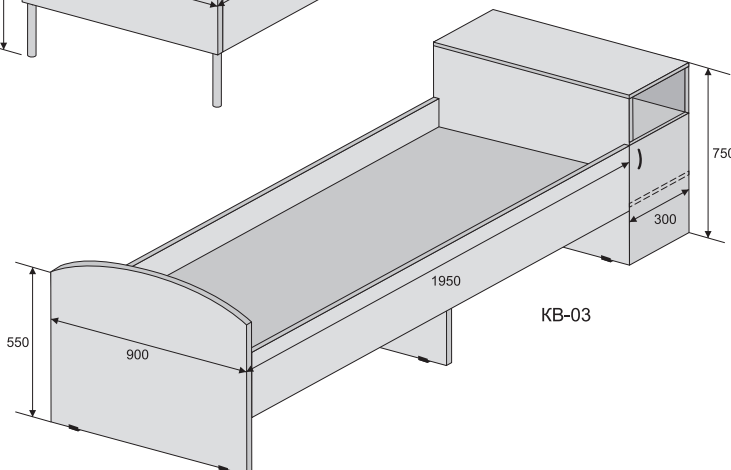

KB-03



Кровати (детские)

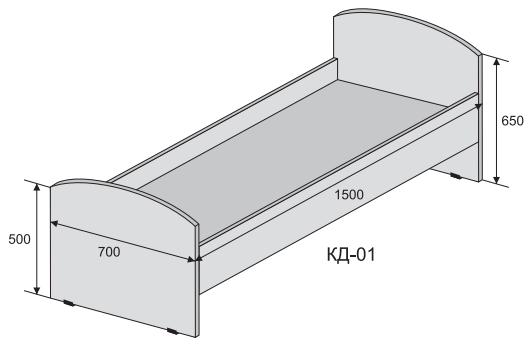

КД-01

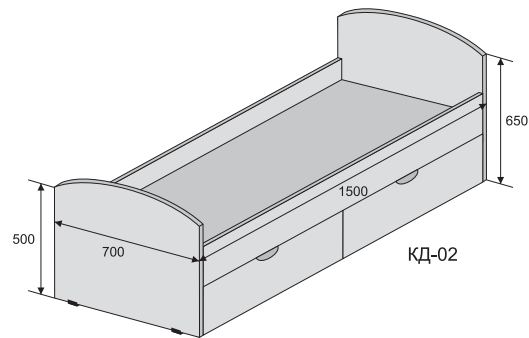

КД-02



Столы лабораторные

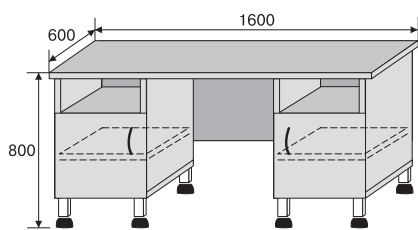

СЛ-01

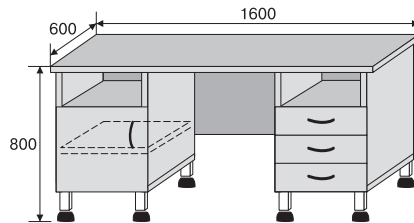

СЛ-02

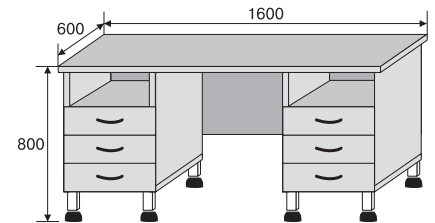

СЛ-03

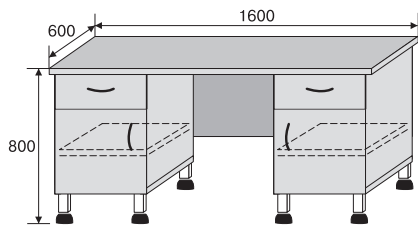

СЛ-04

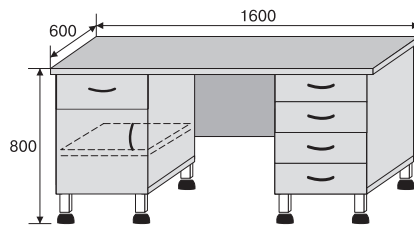

СЛ-05

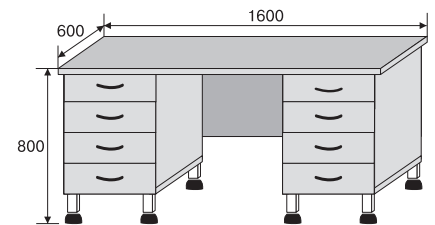

СЛ-06

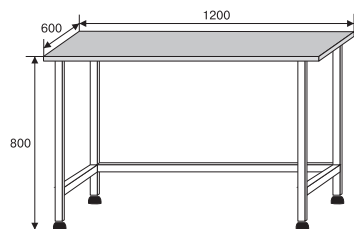

СЛ-07

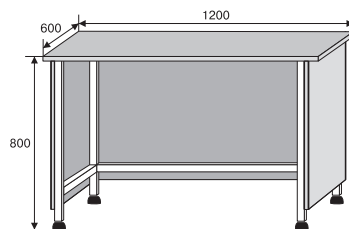

СЛ-08

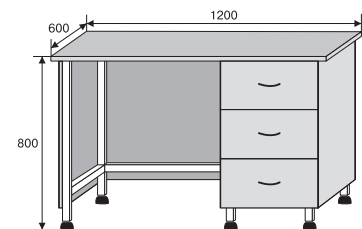

СЛ-09

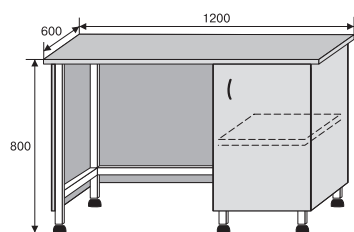

СЛ-10

XXIV Шкафы лабораторные

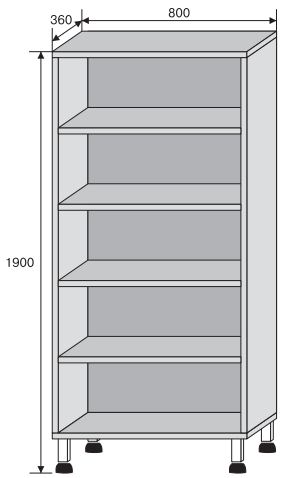

ШЛ-01

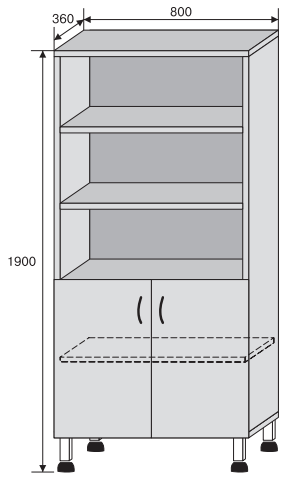

ШЛ-02

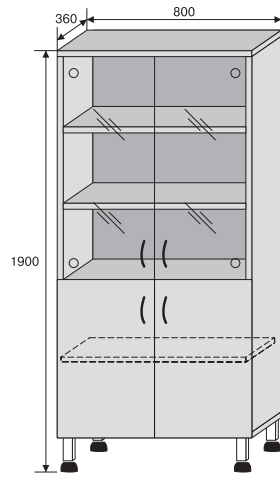

ШЛ-03

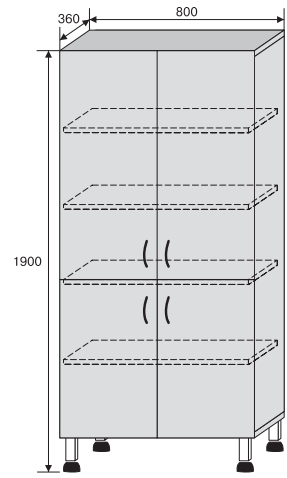

ШЛ-04

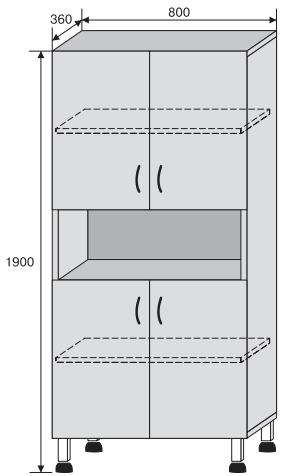

ШЛ-05

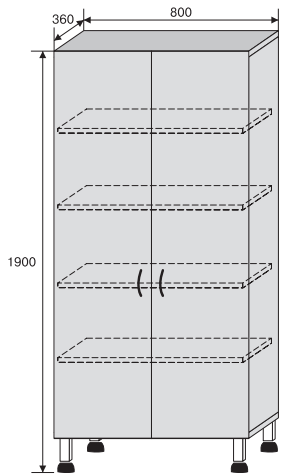

ШЛ-06

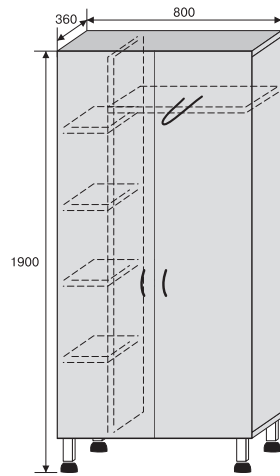

ШЛ-07

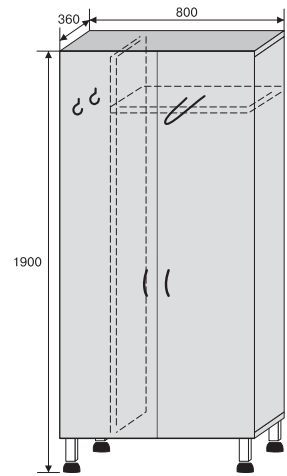

ШЛ-08

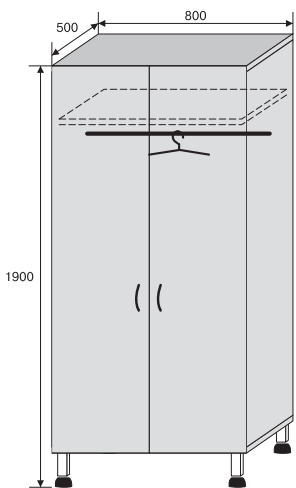

ШЛ-09

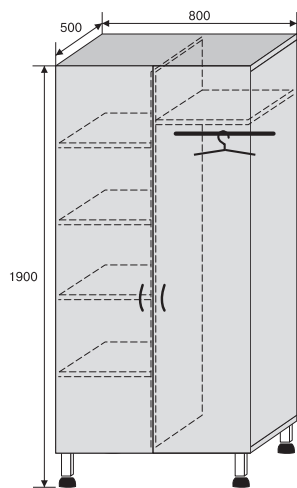

ШЛ-10

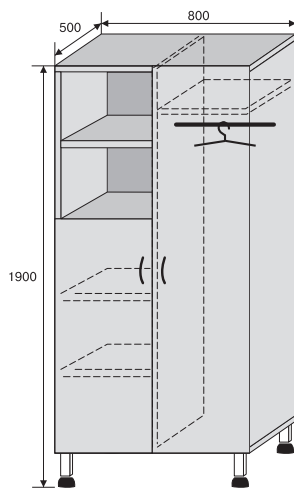

ШЛ-11

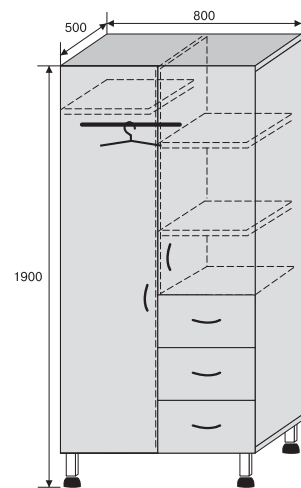

ШЛ-12

xxv Столы пеленальные

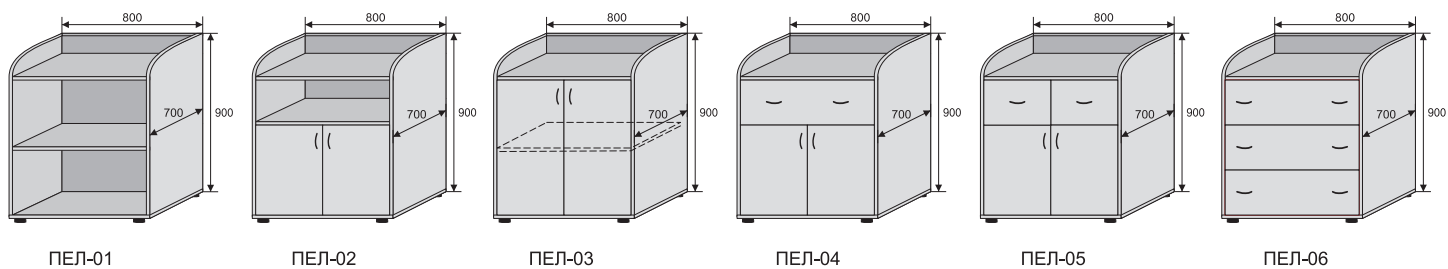

xxvi Тумбы лабораторные

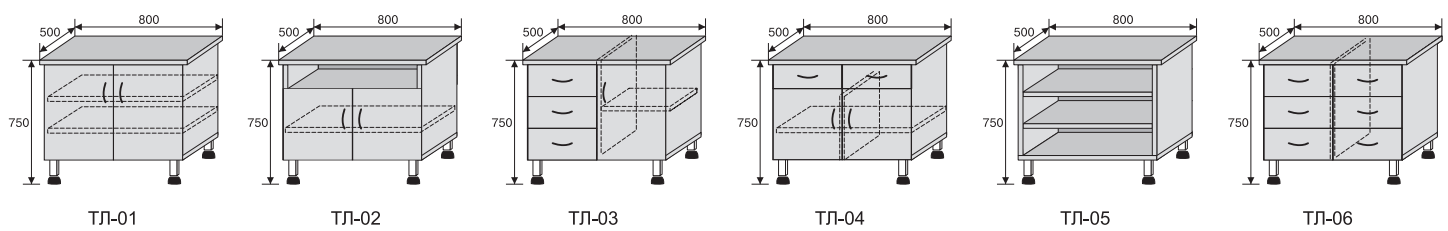

xxvii Мойки лабораторные

а) накладные

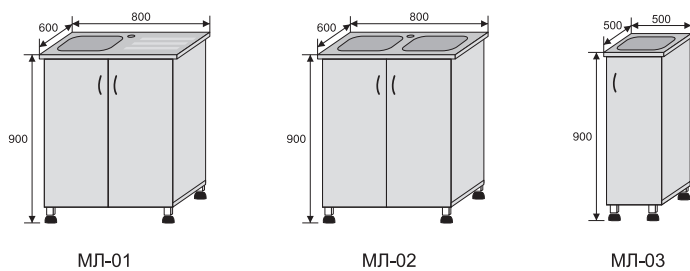

б) врезные

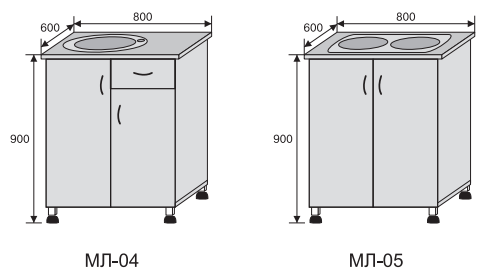

xxviii Сопутствующие товары



банкетка мягкая (двух- или трехместная) табурет мягкий стул ИЗО ткань/металл кресло ПРЕСТИЖ ткань

Варианты расцветок

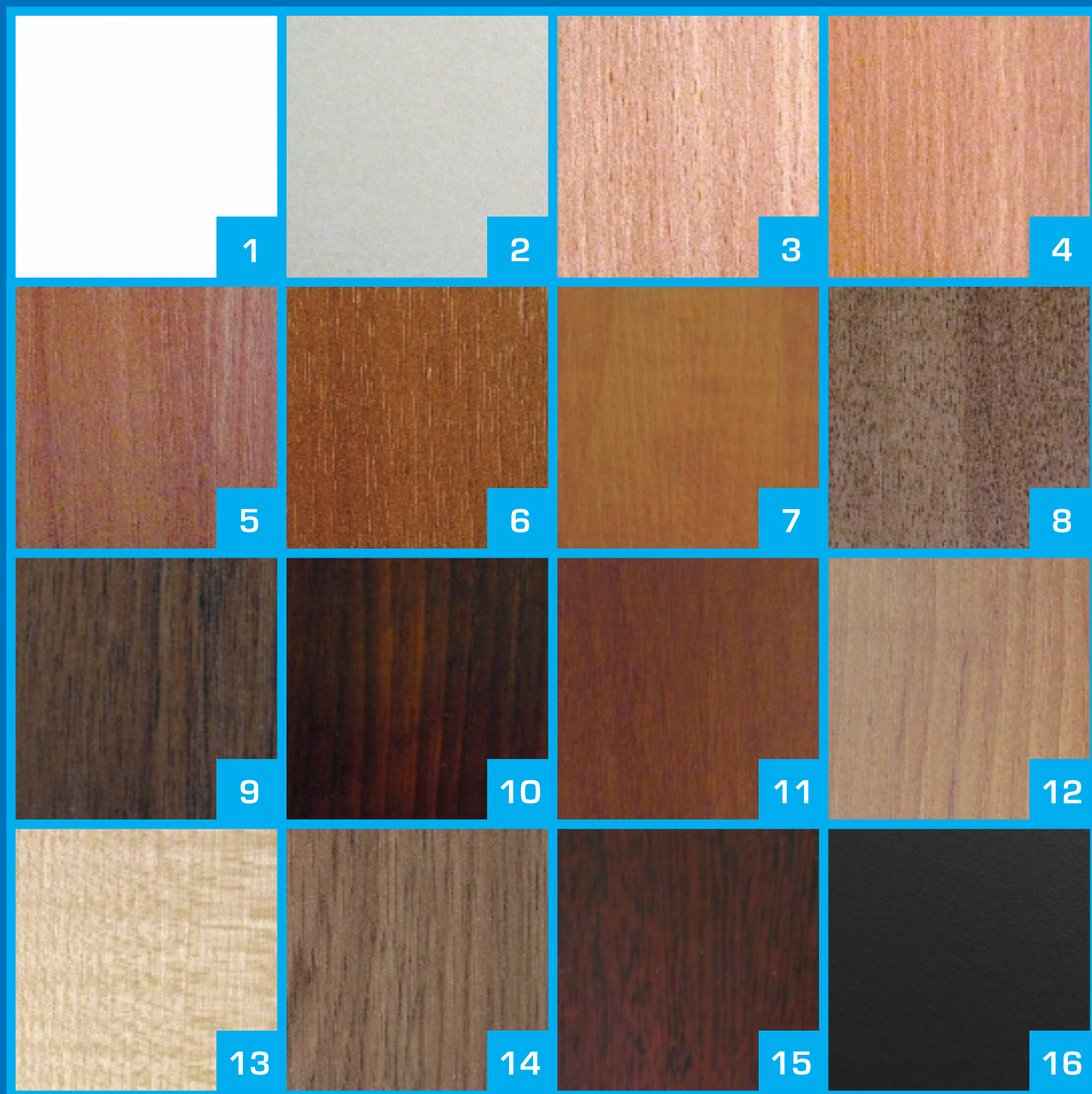

1 – белый

2 – серый

3 – бук светлый

4 – бук темный

5 – вишня оксфорд

6 – вишня темная

7 – груша

8 – орех светлый

9 – орех средний

10 – орех темный

11 – орех итальянский

12 – ольха

13 – клен танзау

14 – дуб седан

15 – махагон

16 – черный